

Panasonic

Operating Instructions

Model No. **KX-TS500MX**

Pulse-or-tone dialing capability



KX-TS500MXW

PLEASE READ BEFORE USE AND SAVE.

For your future reference

Serial No. _____
(found on the bottom of the unit)

Date of purchase _____

Name and address of dealer _____

If trouble occurs, disconnect the unit from the telephone line and connect to a known working phone. If the known working phone operates properly, do not reconnect the unit until the trouble has been repaired. If the known working phone does not operate properly, consult your telephone company.

Panasonic System Networks Co., Ltd.

1-62, 4-chome, Minoshima, Hakata-ku,
Fukuoka 812-8531, Japan

PQQX13679VA F0403SS51110

1 Getting Started

1-A Location of controls

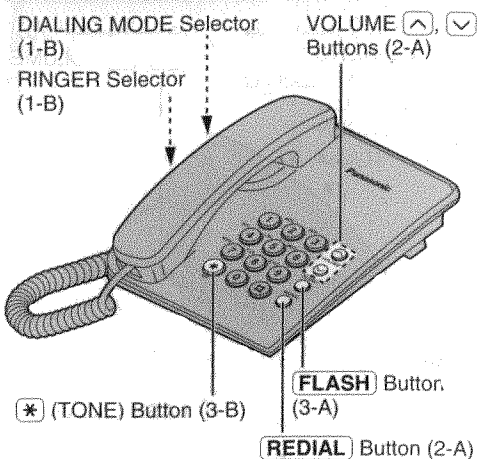

Accessories (included)

- Handset one
- Telephone Line Cord one
- Handset Cord one

1-B Settings

- 1 Connect the telephone line cord (①).
- 2 Connect the handset cord (②), then confirm the dial tone.

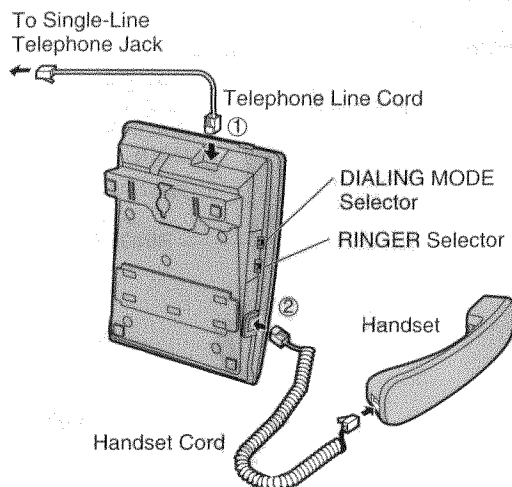

- 3 Set the DIALING MODE selector to TONE.
 - If you cannot dial, set to PULSE.

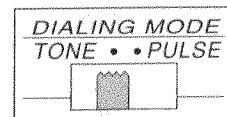

- 4 Set the RINGER selector to HIGH, LOW or OFF. (Ex. "LOW" is selected.)

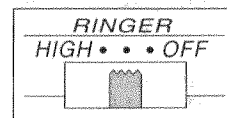

• When set to OFF, the unit will not ring.

2 Operation

2-A Making Calls

- 1 Lift the handset.
- 2 Dial a phone number.
 - If you misdial, hang up and start again from step 1.
- 3 When finished talking, hang up.

To redial the last number dialed
Lift the handset. = Press **REDIAL**.

To adjust the receiver volume (4 levels) while talking

- To increase, press .
- To decrease, press .
- After hanging up, the volume level will be saved.

2-B Answering Calls

- 1 When the unit rings, lift the handset.
- 2 When finished talking, hang up.

3 Special Features

3-A For Call Waiting Service Users

- Press **FLASH** if you hear a call-waiting tone while talking.
- The first call is put on hold and you can answer the second call.
 - To return to the first caller, press **FLASH** again.

3-B Temporary Tone Dialing (For Rotary or Pulse Service Users)

- Press ***** (TONE) before entering access numbers which require tone dialing.
- The dialing mode changes to tone. You can enter numbers to access answering services, electronic banking services, etc. When you hang up, the mode will return to pulse.

4 Things You Should Know

4-A Wall Mounting

The unit can be mounted on a wall.

- 1 Press the tabs in the direction of the arrows (①), then remove the wall mounting adaptor (②).

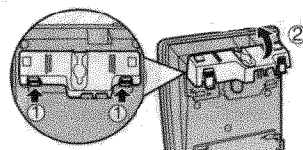

- 2 Tuck the telephone line cord inside the wall mounting adaptor, and push it in the direction of the arrow (① and ②).
 - The word "UP WALL" should face upward.

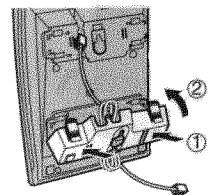

- 3 Install screws using the wall template below. Connect the telephone line cord. Mount the unit, then slide down.
 - Fasten the cord to prevent it from being disconnected.

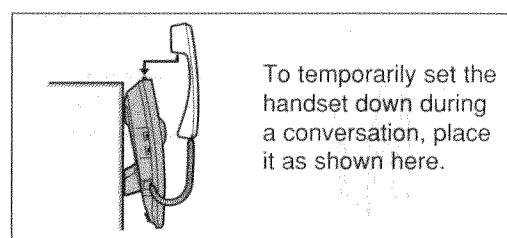
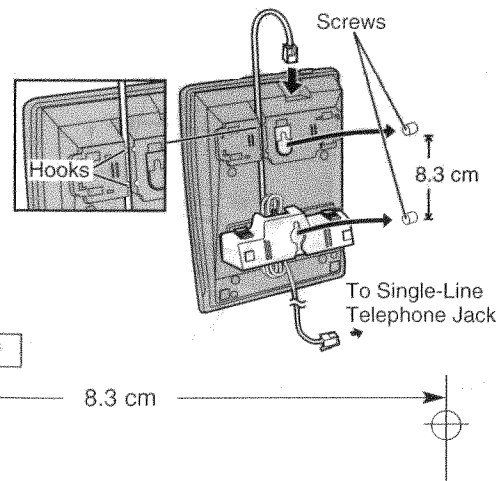

To temporarily set the handset down during a conversation, place it as shown here.

4-B Troubleshooting

Problem	Remedy
The unit does not work.	• Check the settings (1-B).
The call cannot be connected even if you dialed correctly.	• Check whether the DIALING MODE selector setting is correct or not (1-B).
The unit does not ring.	• The RINGER selector is set to OFF. Set to HIGH or LOW (1-B).

4-C Safety Instructions

Take special care to follow the safety suggestions listed below.

Installations Environment

- 1) Do not use this unit near water—for example, near a bathtub, washbowl, sink, etc. Damp basements should also be avoided.
- 2) The unit should be kept away from heat sources such as radiators, kitchen range, etc. It also should not be placed in rooms where the temperature is less than 5°C or greater than 40°C.

Placement

- 1) Do not place heavy objects on top of this unit.
- 2) Care should be taken so that objects do not fall onto, and liquids are not spilled into, the unit. Do not subject this unit to excessive smoke, dust, mechanical vibration or shock.
- 3) Place the unit on a flat surface.

WARNING:

TO PREVENT FIRE OR SHOCK HAZARD, DO NOT EXPOSE THIS PRODUCT TO RAIN OR ANY TYPE OF MOISTURE.

4-D Specifications

- Power Source:** From telephone line
- Dimensions (H x W x D):** Approx. 96 mm x 150 mm x 200 mm
- Mass (Weight):** Approx. 475 g
- Dialing Mode:** Tone (DTMF)/Pulse
- Operating Environment:** 5°C–40°C

Specifications are subject to change without notice.