

Panasonic®

Operating Instructions

Digital Cordless Phone

Model No. **KX-TGK210HK**



***Before initial use, see “Getting Started”
on page 8.***

Thank you for purchasing a Panasonic product.

Please read these operating instructions before using the unit and save them for future reference.

Table of Contents

Introduction		Index	
Accessory information	3	Index.....	36
Graphical symbols for use on equipment and their descriptions	4		
Important Information			
For your safety	5		
Important safety instructions	6		
For best performance	6		
Other information	7		
Specifications	7		
Getting Started			
Setting up	8		
Controls	10		
Display icons	11		
Turning the power on/off	12		
Language setting	12		
Date and time	12		
Other settings	13		
Making/Answering Calls			
Making calls	14		
Answering calls	14		
Useful features during a call	14		
Intercom	16		
Key lock	16		
Phonebook			
Phonebook	17		
Speed dial	18		
Programming			
Menu list	19		
Alarm	23		
Do not disturb mode	23		
Nuisance call block	24		
Other programming	25		
Registering a unit	25		
Caller ID Service			
Using Caller ID service	28		
Caller list	28		
Useful Information			
Voicemail service	30		
Character entry	30		
Error messages	32		
Troubleshooting	32		

Accessory information

Supplied accessories

No.	Accessory item/Part number	Quantity
①	AC adaptor/PNLV226E	1
②	Telephone line cord	2
③	Rechargeable batteries*1	2
④	Handset cover	1

*1 See page 3 for replacement battery information.



Additional/replacement accessories

Please contact your nearest Panasonic dealer for sales information.
For enquiry, please call hotline 2313 0666.

Accessory item	Model number/Specifications
Rechargeable batteries*1	Battery type: – Nickel metal hydride (Ni-MH) – 2 x AAA (R03) size for each handset – 1.2 V – Minimum amperage of 550 mAh
DECT repeater	KX-A405, KX-A406

*1 Replacement batteries may have a different capacity from that of the supplied batteries.
We recommend using Panasonic rechargeable batteries.

Other information













- Design and specifications are subject to change without notice.
- The illustrations in these instructions may vary slightly from the actual product.

Note:

- You can purchase KX-TGK210 separately and use it as an optional handset.
At first, deregister the handset from the base unit additionally purchased (page 26), then re-register it to the base unit which is currently used (page 26).
Additional base unit is used as charger.
 - You do not have to connect the telephone line cord to additional base unit.
 - [☎] of additional base unit is not available.

Introduction

Graphical symbols for use on equipment and their descriptions

Symbol	Explanation	Symbol	Explanation
	Alternating current (A.C.)		Class II equipment (equipment in which protection against electric shock relies on Double Insulation or Reinforced Insulation)
	Direct current (D.C.)		"ON" (power)
	Protective earth		"OFF" (power)
	Protective bonding earth		Stand-by (power)
	Functional earth		"ON"/"OFF" (power; push-push)
	For indoor use only		Caution, risk of electric shock

Important Information

For your safety

To prevent severe injury and loss of life/property, read this section carefully before using the product to ensure proper and safe operation of your product.

WARNING

Power connection

- Use only the power source marked on the product.
- Do not overload power outlets and extension cords. This can result in the risk of fire or electric shock.
- Completely insert the AC adaptor/power plug into the power outlet. Failure to do so may cause electric shock and/or excessive heat resulting in a fire.
- Regularly remove any dust, etc. from the AC adaptor/power plug by pulling it from the power outlet, then wiping with a dry cloth. Accumulated dust may cause an insulation defect from moisture, etc. resulting in a fire.
- Unplug the product from power outlets if it emits smoke, an abnormal smell, or makes an unusual noise. These conditions can cause fire or electric shock. Confirm that smoke has stopped emitting and contact an authorised service centre.
- Unplug from power outlets and never touch the inside of the product if its casing has been broken open.
- Never touch the plug with wet hands. Danger of electric shock exists.

Installation

- To prevent the risk of fire or electrical shock, do not expose the product to rain or any type of moisture.
- Do not place or use this product near automatically controlled devices such as automatic doors and fire alarms. Radio waves emitted from this product may cause such devices to malfunction resulting in an accident.

- Do not allow the AC adaptor or telephone line cord to be excessively pulled, bent or placed under heavy objects.

Operating safeguards

- Unplug the product from power outlets before cleaning. Do not use liquid or aerosol cleaners.
- Do not disassemble the product.
- Do not spill liquids (detergents, cleansers, etc.) onto the telephone line cord plug, or allow it to become wet at all. This may cause a fire. If the telephone line cord plug becomes wet, immediately pull it from the telephone wall jack, and do not use.

Medical

- Consult the manufacturer of any personal medical devices, such as pacemakers or hearing aids, to determine if they are adequately shielded from external RF (radio frequency) energy. (The product operates in the frequency range of 1.88 GHz to 1.90 GHz, and the RF transmission power is 250 mW (max.).)
- Do not use the product in health care facilities if any regulations posted in the area instruct you not to do so. Hospitals or health care facilities may be using equipment that could be sensitive to external RF energy.

CAUTION

Installation and location

- Never install telephone wiring during an electrical storm.
- Never install telephone line jacks in wet locations unless the jack is specifically designed for wet locations.
- Never touch uninsulated telephone wires or terminals unless the telephone line has been disconnected at the network interface.
- Use caution when installing or modifying telephone lines.
- The AC adaptor is used as the main disconnect device. Ensure that the AC outlet is installed near the product and is easily accessible.

Important Information

- This product is unable to make calls when:
 - the handset batteries need recharging or have failed.
 - there is a power failure.
 - the key lock feature is turned on.

Battery

- We recommend using the batteries noted on page 3. **USE ONLY rechargeable Ni-MH batteries AAA (R03) size.**
- Do not mix old and new batteries.
- Do not open or mutilate the batteries. Released electrolyte from the batteries is corrosive and may cause burns or injury to the eyes or skin. The electrolyte is toxic and may be harmful if swallowed.
- Exercise care when handling the batteries. Do not allow conductive materials such as rings, bracelets, or keys to touch the batteries, otherwise a short circuit may cause the batteries and/or the conductive material to overheat and cause burns.
- Charge the batteries provided with or identified for use with this product only, in accordance with the instructions and limitations specified in this manual.
- Only use a compatible base unit (or charger) to charge the batteries. Do not tamper with the base unit (or charger). Failure to follow these instructions may cause the batteries to swell or explode.

Important safety instructions

When using your product, basic safety precautions should always be followed to reduce the risk of fire, electric shock, and injury to persons, including the following:

1. Do not use this product near water for example, near a bathtub, washbowl, kitchen sink, or laundry tub, in a wet basement or near a swimming pool.
2. Avoid using a telephone (other than a cordless type) during an electrical storm. There may be a remote risk of electric shock from lightning.
3. Do not use the telephone to report a gas leak in the vicinity of the leak.

4. Use only the power cord and batteries indicated in this manual. Do not dispose of batteries in a fire. They may explode. Check with local codes for possible special disposal instructions.

SAVE THESE INSTRUCTIONS

For best performance

Base unit location/avoiding noise

The base unit and other compatible Panasonic units use radio waves to communicate with each other.

- For maximum coverage and noise-free communications, place your base unit:
 - at a convenient, high, and central location with no obstructions between the handset and base unit in an indoor environment.
 - away from electronic appliances such as TVs, radios, personal computers, wireless devices, or other phones.
 - facing away from radio frequency transmitters, such as external antennas of mobile phone cell stations. (Avoid putting the base unit on a bay window or near a window.)
- Coverage and voice quality depends on the local environmental conditions.
- If the reception for a base unit location is not satisfactory, move the base unit to another location for better reception.

Environment

- Keep the product away from electrical noise generating devices, such as fluorescent lamps and motors.
- The product should be kept free from excessive smoke, dust, high temperature, and vibration.
- The product should not be exposed to direct sunlight.
- Do not place heavy objects on top of the product.
- When you leave the product unused for a long period of time, unplug the product from the power outlet.
- The product should be kept away from heat sources such as heating devices, cooking

Important Information

appliances, etc. It should not be placed in rooms where the temperature is less than 0 °C or greater than 40 °C. Damp basements should also be avoided.

- The maximum calling distance may be shortened when the product is used in the following places: Near obstacles such as hills, tunnels, underground, near metal objects such as wire fences, etc.
- Operating the product near electrical appliances may cause interference. Move away from the electrical appliances.

Routine care

- **Wipe the outer surface of the product with a soft moist cloth.**
- Do not use benzine, thinner, or any abrasive powder.

Other information

CAUTION: Risk of explosion if battery is replaced by an incorrect type. Dispose of used batteries according to the instructions.

Notice for product disposal, transfer, or return

- This product can store your private/confidential information. To protect your privacy/confidentiality, we recommend that you erase information such as phonebook or caller list entries from the memory before you dispose of, transfer, or return the product.

Information on Disposal in other Countries outside the European Union

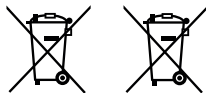

These symbols are only valid in the European Union. If you wish to discard these items,

please contact your local authorities or dealer and ask for the correct method of disposal.

Note for the battery removal procedure

Refer to "Removing the handset cover and battery" on page 9.

Specifications

- **Standard:**
DECT (Digital Enhanced Cordless Telecommunications),
GAP (Generic Access Profile)
- **Number of channels:**
120 Duplex Channels
- **Frequency range:**
1.88 GHz to 1.90 GHz
- **RF transmission power:**
Approx. 10 mW (average power per channel)
250 mW (max.)
- **Power source:**
100–240 V AC, 50/60 Hz
- **Power consumption:**
Base unit:
Standby: 0.5 W
Maximum: 2.5 W
- **Operating conditions:**
0 °C–40 °C, 20 %–80 % relative air humidity (dry)
- **Dimensions:**
Base unit: Approx. 193 mm × 64 mm × 70 mm
Handset: Approx. 177 mm × 51 mm × 31 mm
- **Mass (weight):**
Base unit: Approx. 140 g
Handset: Approx. 150 g

Getting Started

Setting up

Connections

■ Base unit

- ① Connect the AC adaptor to the unit by pressing the plug firmly.
- ② Connect the AC adaptor to the power outlet.
- ③ Connect the telephone line cord to the unit, then to the telephone line jack until you hear a click.
- ④ Fasten the cord by hooking it.
- ⑤ A DSL/ADSL filter (not supplied) is required if you have a DSL/ADSL service.

Note:

- Use only the supplied Panasonic AC adaptor PNLV226E.
- Use only the supplied telephone line cord.

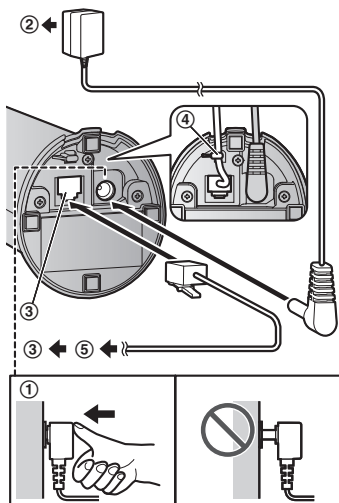

Battery installation/setting the handset cover

- USE ONLY rechargeable Ni-MH batteries AAA (R03) size (A).
- Do NOT use alkaline/manganese/Ni-Cd batteries.
- Confirm correct polarities (+, -).

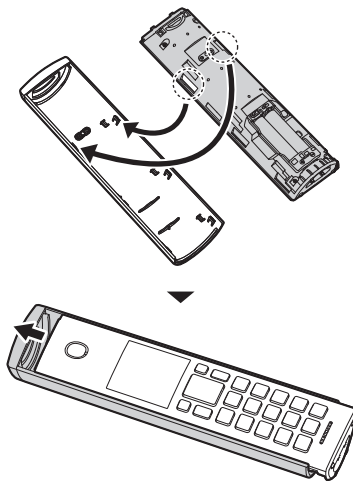
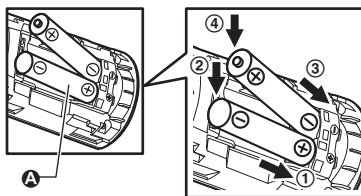

- Follow the directions on the display to set up the unit.

Removing the handset cover and battery

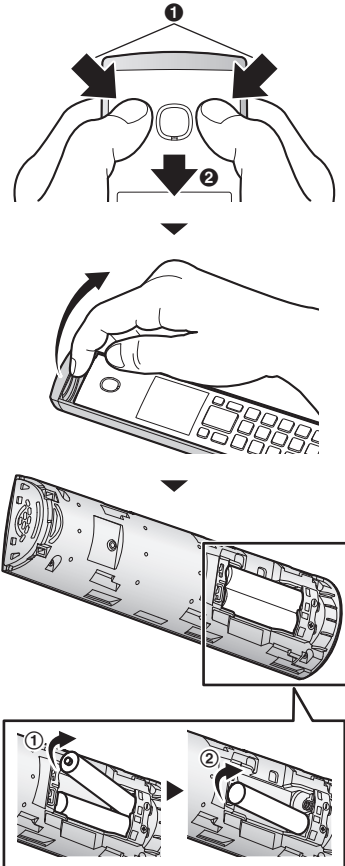

Battery charging

Charge for about 7 hours.

- When the handset is placed on the base unit, a beep is heard and the message indicator lights up about 5 seconds (A).

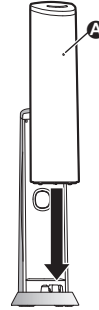

Note when setting up

Note for connections

- The AC adaptor must remain connected at all times. (It is normal for the adaptor to feel warm during use.)
- The AC adaptor should be connected to a vertically oriented or floor-mounted AC outlet. Do not connect the AC adaptor to a horizontally oriented AC outlet that faces the floor, such as an AC outlet installed on a ceiling or under a table, as the weight of the adaptor may cause it to become disconnected.
- If the unit is connected to a PBX system, please contact your PBX supplier.

Power failure

- The unit cannot be used to make or receive calls during a power failure. We recommend connecting a corded-type telephone that does not use an AC adaptor to your telephone line.

Note for battery installation

- Use the supplied rechargeable batteries. For replacement, we recommend using the



Getting Started

Panasonic rechargeable batteries noted on page 3, 6.

Note for battery charging

- It is normal for the handset to feel warm during charging.
- Clean the charge contacts of the handset, base unit, and charger with a soft and dry cloth once a month. Before cleaning the unit, disconnect from power outlets and any telephone line cords. Clean more often if the unit is exposed to grease, dust, or high humidity.

Battery level

Icon	Battery level
	Full
	Low
	Needs charging.

Ni-MH battery performance (supplied batteries)

Operation	Operating time
In continuous use	18 hours max.
Not in use (standby)	200 hours max.

Note:

- To maximise battery life, it is recommended that the handset batteries be fully discharged (used) until  flashes once every few months.
- Actual battery performance depends on usage and ambient environment.

Controls

Base unit

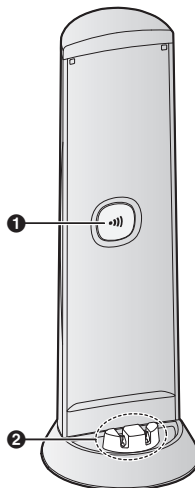

1 (Locator)

- You can locate a misplaced handset by pressing .

2 Charge contacts

Handset

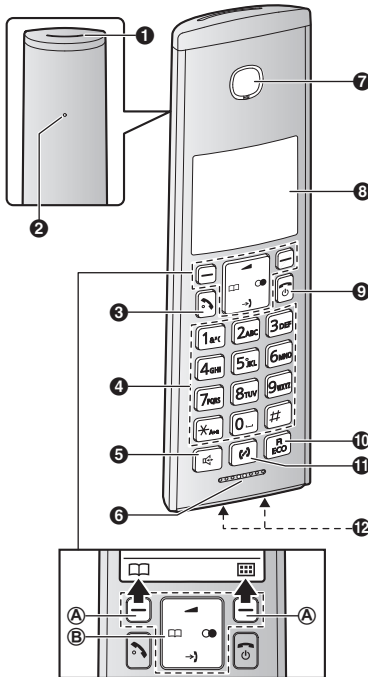

- 1 Speaker
- 2 Message indicator
- 3 (Talk)
- 4 Dial keypad
- 5 (Speakerphone)
- 6 Microphone
- 7 Receiver
- 8 Display
- 9 (Off/Power)
- 10 **[R/ECO]**
R: Recall/Flash
ECO: Eco mode shortcut key
- 11 (Intercom)
- 12 Charge contacts

Control type

A Soft keys

By pressing a soft key, you can select the feature shown directly above it on the display.

B Navigator key

Navigator keys functions as follows.

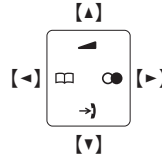

- **[▲]**, **[▼]**, **[◀]**, or **[▶]**: Scroll through various lists and items.
- **[▲]** or **[▼]** (▶): Adjust the receiver or speaker volume while talking.
- **[▶]** (Caller list): View the caller list.
- **[☎]** (Phonebook): View the phonebook entry.
- **[●]** (Redial): View the redial list.

Display icons

Handset display items

Item	Meaning
	Range status: The more bars visible, the closer the handset is to the base unit.
	Out of base unit range
	Paging, intercom mode
	Speakerphone is on. (page 14)
	The line is in use. <ul style="list-style-type: none"> ● When flashing slowly: The call is on hold. ● When flashing rapidly: An incoming call is now being received.
	Missed call*1 (page 28)
ECO	Eco mode is set to "Eco". (page 13)

Getting Started

Item	Meaning
	The LCD and key backlight is off. (page 21)
	Battery level
	Alarm is on. (page 23)
	Privacy mode is on. (page 21)
	Ringer volume is off. (page 20)
	Do not disturb mode is on. (page 23)
	Nuisance call blocked.*1 (page 24)
	New voicemail message received.*2 (page 30)
Line in use	Someone is using the line.

*1 Caller ID subscribers only

*2 Voicemail subscribers only

Handset soft key icons

Icon	Action
	Returns to the previous screen or outside call.
	Displays the menu.
OK	Accepts the current selection.
	Makes a call. (page 14)
	Temporarily turns off the ringer for incoming calls. (page 14)
	Places a call on hold.
	Opens the phonebook.
	Allows you to edit phone numbers. (page 24)
	Adds new entry. (page 18)
	Displays the phonebook search menu.
	Turns the key lock feature off. (page 16)
	Stops alarm. (page 23)

Icon	Action
	Snooze button on the alarm. (page 23)
✓	Selects entries or handsets. (page 13, 23)
	Stores phone numbers. (page 17)
✕	Erases the selected item.
	Allows you to make an intercom call. (page 16)
C	Erases a number/character.
	Puts the call on mute.

Turning the power on/off

Press [] for about 2 seconds.

Language setting

Display language

- 1 []#1101
- 2 []: Select your desired language. → [OK] → []

Date and time

- 1 []#1001
- 2 Enter the current date, month, and year. → [OK]
Example: 12 July, 2017
1 2 0 7 1 7
- 3 Enter the current hour and minute.
Example: 9:30
0 9 3 0
 - You can select 24-hour or 12-hour clock format (“AM” or “PM”) by pressing .
- 4 [OK] → []

Other settings

Message indicator

The message indicator is located on the back of the handset and informs you of the following status with its flashing.

Indicator	Status
Flashing rapidly	<ul style="list-style-type: none"> – Incoming call or intercom call are now being received. (page 14, 16) – An alarm sounds. (page 23)
Flashing slowly*1	<ul style="list-style-type: none"> – There are missed calls. (page 28)

*1 To activate, setting of message indicator must be "On". (page 13)

Setting the message indicator

The message indicator for the following feature must be "On".

– "Missed Call" (Default: Off)

- 1 **[☰]#278**
- 2 **[✓]**
 - "✓" is displayed next to the selected feature.
 - To cancel a selected feature, press **[✓]** again. "✓" disappears.
- 3 **[OK] → [📞]**

Note:

- If the message indicator flashes when the handset is not placed on the base unit, battery consumption is faster than usual.

Eco mode setting

You can select the desired eco mode setting by pressing **[R/ECO]**.

The following settings are available for eco mode.

- "Eco": Reduces the base unit transmission power by up to 90 % in standby mode.

When this setting is selected, **[ECO]** is displayed on the handset display instead of **[📞]**.

- "Eco Off" (default setting): Turns off eco mode.

When this setting is selected, **[ECO]** is not displayed in the handset display.

Note:

- When there is another cordless phone in use nearby, the base unit transmission power may not be reduced.
- When eco mode is active, the range of the base unit is reduced in standby mode.
- If you set repeater mode to "On" (page 27):
 - Eco mode is disabled.
 - "Eco Mode" is not displayed in the display menu (page 20).

Dialling mode

If you cannot make calls, change this setting according to your telephone line service. The default setting is "Tone".

"Tone": For tone dial service.

"Pulse": For rotary/pulse dial service.

- 1 **[☰]#120**
- 2 **[+] : Select the desired setting. → [OK] → [📞]**

Making/Answering Calls

Making calls

- 1 Lift the handset and dial the phone number.
 - To correct a digit, press [C].
- 2 Press [📞] to make the call.
 - To make the call using the speakerphone, press [📞].
- 3 When you finish talking, press [📞] or place the handset on the base unit or charger.

Note:

- To switch to the speaker, press [📞].
To switch back to the receiver, press [📞]/[📞].

Adjusting the receiver or speaker volume

Press [▲] or [▼] repeatedly while talking.

Making a call using the redial list

The last 10 phone numbers dialled are stored in the redial list (24 digits max. each).

- 1 [📞]
- 2 [↕]: Select the desired entry.
- 3 [📞]

Erasing a number in the redial list

- 1 [📞]
- 2 [↕]: Select the desired entry. → [X]
- 3 [↕]: "Yes" → [OK] → [📞]

Pause (for PBX/long distance service users)

A pause is sometimes required when making calls using a PBX or long distance service. When storing a calling card access number and/or PIN in the phonebook, a pause is also needed (page 18).

Example: If you need to dial the line access number "0" when making outside calls with a PBX:

- 1 [0] → [▲] (Pause)

- 2 Dial the phone number. → [📞]

Note:

- A 3 second pause is inserted each time [▲] (Pause) is pressed.

Answering calls

- 1 Lift the handset and press [📞] or [📞] when the unit rings.
- 2 When you finish talking, press [📞] or place the handset on the base unit or charger.

Any key answer: You can answer the call by pressing any dial key.

Auto talk: You can answer calls simply by lifting the handset (page 21).

Temporary handset ringer off: You can turn the ringer off temporarily by pressing [📞].

Adjusting the ringer volume

Press [▲] or [▼] repeatedly to select the desired volume while ringing.

Useful features during a call

Hold

- 1 Press [📞] during an outside call.
- 2 [↕]: "Hold" → [OK]
- 3 To release hold, press [📞].

Note:

- After holding for 10 minutes, the call is disconnected.

Mute

- 1 Press [📞] during a call.
- 2 To return to the call, press [📞].

Recall/flash

[R/ECO] allows you to use the special features of your host PBX such as transferring an extension call, or accessing optional telephone services.

Note:

- To change the recall/flash time, see page 21.

For call waiting or Call Waiting Caller ID service users

To use call waiting or Call Waiting Caller ID, you must first subscribe with your phone service provider.

This feature allows you to receive calls while you are already talking on the phone. If you receive a call while on the phone, you will hear a call waiting tone.

If you subscribe to both Caller ID and Call Waiting with Caller ID services, the 2nd caller's information is displayed on the unit that is in use after you hear the call waiting tone.

- 1 Press **[R/ECO]** to answer the 2nd call.
- 2 To switch between calls, press **[R/ECO]**.

Note:

- Please contact your phone service provider for details and availability of this service in your area.

Temporary tone dialling (for rotary/pulse service users)

Press **[X]** before entering access numbers which require tone dialling.

Handset equalizer

This feature clarifies the voice of the person you are talking to, producing a more natural-sounding voice that is easier to hear and understand.

- 1 Press **[EQ]** while talking.
- 2 **[↕]**: "Equalizer" → **[OK]**
- 3 **[↕]**: Select the desired setting.

- 4 Press **[OK]** to exit.

Note:

- Depending on the condition and quality of your telephone line, this feature may emphasise existing line noise. If it becomes difficult to hear, turn this feature off.
- This feature is not available while using the speakerphone.

Call share

You can join an existing outside call. To join the conversation, press **[↶]** when the other handset is on an outside call.

Note:

- To prevent other users from joining your conversations with outside callers, turn the privacy mode on (page 21).

Transferring calls, conference calls

Outside calls can be transferred or a conference call with an outside party can be made between handsets in the same radio cell.

- 1 During an outside call, press **[↶]**.
When 3 or more handsets are registered:
[↕]: Select the desired unit. → **[OK]**
- 2 Wait for the paged party to answer.
 - If the paged party does not answer, press **[↷]** to return to the outside call.
- 3 **To complete the transfer:**
Press **[↶]**.
To establish a conference call:
[EQ] → **[↕]**: "Conference" → **[OK]**
 - To leave the conference, press **[↶]**.
The other 2 parties can continue the conversation.
 - To put the outside call on hold: **[EQ]** → **[↕]**: "Hold" → **[OK]**
To resume the conference: **[EQ]** → **[↕]**: "Conference" → **[OK]**
 - To cancel the conference: **[EQ]** → **[↕]**: "Stop Conference" → **[OK]**
You can continue the conversation with the outside caller.

Making/Answering Calls

Intercom

Intercom calls can be made between handsets in the same radio cell.

Note:

- When paging the handset, the paged handset beeps for 1 minute.
- If you receive an outside call while talking on the intercom, the interrupt tone sounds. To finish intercom, press [📞]. To answer the call, press [📞].

Making an intercom call

- 1 [📞]
When 3 or more handsets are registered:
[📞]: Select the desired unit. → [OK]
- 2 When you finish talking, press [📞].

Answering an intercom call

- 1 Press [📞] to answer the page.
- 2 When you finish talking, press [📞].

Key lock

The handset can be locked so that no calls or settings can be made. Incoming calls can be answered, but all other functions are disabled while key lock is on.

To turn key lock on, press [🔒] for about 3 seconds.

- To turn key lock off, press [🔒-O] for about 3 seconds.

Note:

- Calls to emergency numbers cannot be made until key lock is turned off.

Phonebook

You can add 50 names (16 characters max.) and phone numbers (24 digits max.) to the phonebook.

Important:

- All entries can be shared by any registered handset.

Adding phonebook entries

- 1 [OK] → [☰]
- 2 [↕]: "New Entry" → [OK]
- 3 Enter the party's name. → [OK]
 - You can change the character entry mode by pressing [R/ECO] (page 30).
- 4 Enter the party's phone number. → [OK]
- 5 [OK] → [☎]

Storing a redial list number to the phonebook

- 1 [●]
- 2 [↕]: Select the desired entry. → [☰]
- 3 To store the name, continue from step 3, "Editing entries", page 17.

Storing caller information to the phonebook

- 1 [→]
- 2 [↕]: Select the desired entry. → [☰]
- 3 [↕]: "Save Phonebook" → [OK]
- 4 To store the name, continue from step 3, "Editing entries", page 17.

Finding and calling from a phonebook entry

- 1 [OK]
- 2 To scroll through all entries [↕]: Select the desired entry.
To search by first character

- ① Press the dial key ([0] to [9], or [#]) which contains the character you are searching for (page 30).
- ② [↕]: Scroll through the phonebook if necessary.

3 [☎]

Editing entries

- 1 Find the desired entry (page 17). → [☰]
- 2 [↕]: "Edit" → [OK]
- 3 Edit the name if necessary. → [OK]
- 4 Edit the phone number if necessary. → [OK]
- 5 [OK] → [☎]

Erasing entries

Erasing an entry

- 1 Find the desired entry (page 17). → [☰]
- 2 [↕]: "Erase" → [OK]
- 3 [↕]: "Yes" → [OK] → [☎]

Erasing all entries

- 1 [OK] → [☰]
- 2 [↕]: "Erase All" → [OK]
- 3 [↕]: "Yes" → [OK]
- 4 [↕]: "Yes" → [OK] → [☎]

Chain dial

This feature allows you to dial phone numbers in the phonebook while you are on a call. This feature can be used, for example, to dial a calling card access number or bank account PIN that you have stored in the phonebook, without having to dial manually.

- 1 During an outside call, press [OK].
- 2 [↕]: Select the desired entry.
- 3 Press [☎] (right soft key) to dial the number.

Phonebook

Note:

- When storing a calling card access number and your PIN in the phonebook as one phonebook entry, press **[▲]** (Pause) to add pauses after the number and PIN as necessary (page 14).
- If you have rotary/pulse service, you need to press **[☒]** before pressing **[☐]** in step 1 to change the dialling mode temporarily to tone. When adding entries to the phonebook, we recommend adding **[☒]** to the beginning of phone numbers you wish to chain dial (page 17).

Speed dial

You can assign 1 phone number to each of the dial keys (**[1]** to **[9]**) on the handset.

Adding phone numbers to speed dial keys

■ By entering phone numbers:

- 1 Press and hold the desired speed dial key (**[1]** to **[9]**). → **[☐☒]**
- 2 **[↕]**: “Manual” → **[OK]**
- 3 Enter the party's name (16 characters max.). → **[OK]**
- 4 Enter the party's phone number (24 digits max.). → **[OK]** 2 times → **[☎]**

■ From the phonebook:

- 1 Press and hold the desired speed dial key (**[1]** to **[9]**). → **[☐☒]**
- 2 **[↕]**: “Phonebook” → **[OK]**
- 3 **[↕]**: Select the desired entry. → **[OK]** → **[☎]**

Note:

- If you edit a phonebook entry which is assigned to a speed dial key, the edited entry does not transfer to the speed dial key.

Editing an entry

- 1 Press and hold the desired speed dial key (**[1]** to **[9]**). → **[☐☐]**
- 2 **[↕]**: “Edit” → **[OK]**
- 3 Edit the name if necessary. → **[OK]**
- 4 Edit the phone number if necessary. → **[OK]** 2 times → **[☎]**

Erasing an entry

- 1 Press and hold the desired speed dial key (**[1]** to **[9]**). → **[☐☐]**
- 2 **[↕]**: “Erase” → **[OK]**
- 3 **[↕]**: “Yes” → **[OK]** → **[☎]**

Viewing an entry/Making a call

- 1 Press and hold the desired speed dial key (**[1]** to **[9]**).
- 2 To make a call, press **[☎]**.







Menu list

To access the features, there are 2 methods.



■ Scrolling through the display menus

- 1 
- 2 Press [**▼**], [**▲**], [**▶**], or [**◀**] to select the desired main menu. → [OK]
- 3 Press [**▼**] or [**▲**] to select the desired item from the next sub-menus. → [OK]
- 4 Press [**▼**] or [**▲**] to select the desired setting. → [OK]

■ Using the direct command code

- 1  → Enter the desired code.
Example: Press      .
- 2 Select the desired setting. → [OK]

Note:

- To exit the operation, press .
- In the following table, < > indicates the default settings.
- In the following table,  indicates the reference page number.
- Display menu order and sub-menu may vary depending on your model.

Display the menu tree and direct command code table

Main menu:  "Time Settings"

Sub-menu 1	Sub-menu 2	Settings	Code	
Set Date/Time* ¹	–	–	#101	12
Memo Alarm	Alarm1-3	<Off> Once Daily Weekly	#720	23
Time Adjustment* ^{1, 2}	–	Caller ID <Manual>	#226	–

Main menu:  "Caller List"

Operation	Code	
Viewing the caller list.	#213	28

Main menu:  "Ringer Setup"

Sub-menu 1	Sub-menu 2	Settings	Code	
Ringer Volume	–	Off-6 <6>	#160	–
Ringtone* ³	–	<Ringtone 1>	#161	–

Programming

Sub-menu 1	Sub-menu 2	Settings	Code	
Do Not Disturb Mode	On/Off	On <Off>	#238	23
	Start/End	<23:00/06:00>	#237	23
	Ring Delay	30 sec. <60 sec.> 90 sec. 120 sec. No Ringing	#239	24
First Ring*1, *4	-	<On> Off	#173	-

Main menu:  "Initial Setup"

Sub-menu 1	Sub-menu 2	Settings	Code	
Ringer Setup	Ringer Volume	Off-6 <6>	#160	-
	Ringtone*3	<Ringtone 1>	#161	-
	Do Not Disturb Mode - On/Off	On <Off>	#238	23
	Do Not Disturb Mode - Start/End	<23:00/06:00>	#237	23
	Do Not Disturb Mode - Ring Delay	30 sec. <60 sec.> 90 sec. 120 sec. No Ringing	#239	24
	First Ring*1, *4	<On> Off	#173	-
Time Settings	Set Date/Time*1	-	#101	12
	Memo Alarm - Alarm1-3	<Off> Once Daily Weekly	#720	23
	Time Adjustment*1, *2	Caller ID <Manual>	#226	-
Nuisance Call Block*1	Single Number	-	#217	24
	Range of Numbers	-		
	Withheld	On <Off>	#240	24
Speed Dial	-	-	#261	18
Eco Mode*1, *5	-	<Off> Eco	#725	13

Programming

Sub-menu 1	Sub-menu 2	Settings	Code	
Display Setup	LCD & Key Backlight	<On> Off	#276	-
	Contrast (Display contrast)	Level 1-4 <2>	#145	-
	Handset Name	-	#104	25
	Display Name	On <Off>	#105	25
Message Indicator	-	-	#278	13
Keytones	-	<On> Off	#165	-
Call Restrict ^{*1}	-	-	#256	25
Auto Talk ^{*6}	-	On <Off>	#200	14
Line Setup	Dial Mode ^{*1}	<Tone> Pulse	#120	13
	Recall/Flash ^{*1, *7}	80 msec. 90 msec. 100 msec. 110 msec. 160 msec. 200 msec. 250 msec. 300 msec. <400 msec.> 600 msec. 700 msec. 900 msec.	#121	15
Privacy Mode ^{*1, *8}	-	On <Off>	#194	-
Base Unit PIN ^{*1}	-	<0000>	#132	25
Repeater Mode ^{*1}	-	On <Off>	#138	27
Register	Register Handset	-	#130	26
	Cancel Register ^{*9}	-	#131	26
Select Base	-	<Auto>	#137	26
Cancel Base ^{*9}	-	-	#139	26
Language	Display	<Ελληνικά>	#110	12

Programming

Main menu:  "Nuisance Call Block"*1

Sub-menu 1	Sub-menu 2	Settings	Code	
Single Number	–	–	#217	24
Range of Numbers	–	–		
Withheld	–	On <Off>	#240	24

Main menu:  "Speed Dial"

Operation	Code	
Viewing the speed dial entry.	#261	18

- *1 If you program these settings using one of the handsets, you do not need to program the same item using another handset.
- *2 This feature allows the unit to automatically adjust the date and time each time caller information including date and time is received.
To turn this feature on, select "Caller ID". To turn this feature off, select "Manual". (Caller ID subscribers only)
To use this feature, set the date and time first (page 12).
- *3 The preset melodies in this product ("Ringtone 3" - "Ringtone 40") are used with permission of © 2012 - 2017 Copyrights Vision Inc.
- *4 If you do not want the unit to ring before the caller information is received, set to "OFF". (Caller ID subscribers only)
You can only remove the first ring if the unit rings 2 times or more by default, which depends on your phone service provider.
- *5 This menu is not displayed when repeater mode is set to "On".
- *6 If you subscribe to a Caller ID service and want to view the caller's information after lifting up the handset to answer a call, turn off this feature.
- *7 The recall/flash time depends on your telephone exchange or host PBX. Contact your PBX supplier if necessary.
- *8 To prevent other users from joining your conversations with outside callers, turn this feature on.
- *9 This menu is not displayed when scrolling through the display menus. It is only available in direct command code.

Alarm

An alarm sounds at the set time for 1 minute and is repeated 5 times at 5 minute intervals (snooze function). A text memo can also be displayed for the alarm. A total of 3 separate alarm times can be programmed for each handset. You can set one of 3 different alarm options (once, daily, or weekly) for each alarm time.

Important:

- Make sure the unit's date and time setting is correct (page 12).

- 1 **[☰] [#] 7 2 0**
- 2 **[↕]**: Select the desired alarm. → **[OK]**
- 3 **[↕]**: Select the desired alarm option. → **[OK]**

"Off"	Turns alarm off. Go to step 9.
"Once"	An alarm sounds once at the set time.
"Daily"	An alarm sounds daily at the set time. Go to step 5.
"Weekly"	Alarm sounds weekly at the set time(s).

- 4 Proceed with the operation according to your selection in step 3.
 - **Once:**
Enter the desired date and month. → **[OK]**
 - **Weekly:**
[↕]: Select the desired day of the week and press **[✓]**. → **[OK]**
- 5 Set the desired time. → **[OK]**
- 6 Enter a text memo (10 characters max.). → **[OK]**
- 7 **[↕]**: Select the desired alarm tone. → **[OK]**
 - We recommend selecting a different ringer tone from the one used for outside calls.

- 8 **[↕]**: Select the desired snooze setting. → **[OK]**

- 9 **[OK]** → **[📞]**

Note:

- Press **[🔕]** to stop the alarm completely.
- When the handset is in use, the alarm will not sound until the handset is in standby mode.
- Press any dial key or **[📞]** to stop the sound but keep the snooze function activated.
- If you want to make an outside call when the snooze function is activated, please stop the snooze function before making the call.

Do not disturb mode

Do not disturb mode allows you to select a period of time during which the handset will not ring for outside calls. This feature is useful for time periods when you do not want to be disturbed, for example, while sleeping. Do not disturb mode can be set for each handset.

Important:

- Make sure the unit's date and time setting is correct (page 12).
- If you have set the alarm, the alarm sounds even if do not disturb mode is turned on.

Turning do not disturb mode on/off

- 1 **[☰] [#] 2 3 8**
- 2 **[↕]**: Select the desired setting. → **[OK]**
 - If you select "Off", press **[🔕]** to exit.
- 3 Enter the desired hour and minute you wish to start this feature. → **[OK]**
- 4 Enter the desired hour and minute you wish to end this feature. → **[OK]** → **[🔕]**

Changing the start and end time

- 1 **[☰] [#] 2 3 7**
- 2 Continue from step 3, "Turning do not disturb mode on/off", page 23.

Programming

Setting the ring delay

This setting allows the handset to ring during do not disturb mode if the caller waits long enough. After the selected amount of time passes, the handset rings. If you select “No Ringing”, the handset never rings during do not disturb mode.

- 1 **[☰]#239**
- 2 **[↕]**: Select the desired setting. → **[OK]**
→ **[📞]**

Nuisance call block

This feature blocks calls from unwanted callers (Caller ID subscribers only). The following items are available when storing phone numbers in the call block list.

- “Single Number”: The unit blocks calls from specific phone numbers.
- “Range of Numbers”: The unit blocks calls that begin with a number stored in the call block list, such as a toll-free phone number prefix or certain area codes.

Single phone numbers and ranges of numbers can be stored in the call block list:

- up to 30 items in total.

You can also set the unit to block calls that have no phone number.

When a call is received, the unit does not ring while the caller is being identified. If the caller’s phone number matches an entry in the call block list, the unit emits no sound to the caller, and disconnects the call.

Important:

- Blocked calls are logged in the caller list.

Storing unwanted callers

Storing a single phone number

Important:

- You must include the area code when storing phone numbers in the call block list.

■ From the caller list:

- 1 **[→]**

- 2 **[↕]**: Select the entry to be blocked. → **[☰]**

- 3 **[↕]**: “Save Call Block” → **[OK]**

- 4 **[↕]**: “Yes” → **[OK]** → **[📞]**

■ By entering phone numbers:

- 1 **[☰]#217**

- 2 **[↕]**: “Single Number” → **[OK]**

- 3 **[☰]** → **[↕]**: “Add” → **[OK]**

- 4 Enter the phone number (24 digits max.).
 - To erase a digit, press **[C]**.

- 5 **[OK]** → **[📞]**

Storing a range of numbers

- 1 **[☰]#217**

- 2 **[↕]**: “Range of Numbers” → **[OK]**

- 3 **[☰]** → **[↕]**: “Add” → **[OK]**

- 4 Enter the desired number (2-8 digits).
 - To erase a digit, press **[C]**.

- 5 **[OK]** → **[📞]**

Blocking incoming calls that have no phone number

You can block calls when no phone number is provided, such as private callers.

- 1 **[☰]#240**

- 2 **[↕]**: Select the desired setting. → **[OK]**

- 3 **[📞]**

Viewing/editing/erasing call block numbers

- 1 **[☰]#217**

- 2 **[↕]**: “Single Number” or “Range of Numbers” → **[OK]**

- 3 **[↕]**: Select the desired entry.
 - To exit, press **[📞]**.

4 To edit a number:

- [☰]** → Edit the number. → **[OK]** → **[📞]**

To erase a number:

[X] → [↕]: “yes” → [OK] → [📞]

Note:

- When editing, press the desired dial key to add digits and press [C] to erase digits.

Erasing all call block numbers

- 1 [☎]#217
- 2 [↕]: “Single Number” or “Range of Numbers” → [OK]
- 3 [☎] → [↕]: “Erase All” → [OK]
- 4 [↕]: “yes” → [OK]
- 5 [↕]: “yes” → [OK] → [📞]

Other programming

Changing the handset name

The default handset name is “Handset 1” to “Handset 6”. You can customise the name of each handset (“Bob”, “Kitchen”, etc.). This is useful when you make intercom calls between handsets. To display the handset name in standby mode, turn on the handset name display feature (page 25).

- 1 [☎]#104
- 2 Enter the desired name (10 characters max.). → [OK] → [📞]

Displaying the handset name

You can select whether or not the handset name is displayed in standby mode. The default setting is “off”.

- 1 [☎]#105
- 2 [↕]: Select the desired setting. → [OK] → [📞]

Call restriction

You can restrict selected handsets from dialling certain numbers. You can assign up to 6 phone numbers to be restricted, and select which handsets are to be restricted. Storing

area codes here prevents the restricted handsets from dialling any phone number in that area code.

- 1 [☎]#256
- 2 Enter the base unit PIN (default: “0000”).
 - If you forget your PIN, contact an authorised service centre.
- 3 [↕]: Select the handsets to be restricted. → [✓]
 - “✓” is displayed next to the selected handset numbers.
 - To cancel the selected handsets: [↕]: Select the handset. → Press [✓] again. “✓” disappears.
- 4 [OK]
- 5 [↕]: Select a memory location. → [OK]
- 6 Enter the phone number or area code to be restricted (8 digits max.). → [OK] → [📞]

Changing the base unit PIN

Important:

- If you change the PIN (Personal Identification Number), please make note of your new PIN. The unit will not reveal the PIN to you. If you forget your PIN, contact an authorised service centre.

- 1 [☎]#132
- 2 Enter the current 4-digit base unit PIN (default: “0000”).
- 3 Enter the new 4-digit base unit PIN. → [OK]
- 4 [↕]: “yes” → [OK] → [📞]

Registering a unit

Operating additional units

Additional handsets

Up to 6 handsets can be registered to the base unit.

Programming

Important:

- The additional handset model recommended for use with this unit is noted on page 3. If another handset model is used, certain operations may not be available.

Additional base units





Handsets can be registered to up to 4 base units, allowing you to add additional base units and extend the area in which your handset(s) can be used. If a handset moves out of range of its base unit when "Auto" is selected on base unit (page 26), it looks for another base unit to make or receive calls. A base unit and the handsets it communicates with is called a "radio cell".

Note:

- Calls are disconnected when the handset moves from one radio cell to another.



Registering a handset to a base unit

The supplied handset and base unit are pre-registered. If for some reason the handset is not registered to the base unit (for example,  is displayed even when the handset is near the base unit), re-register the handset.

- 1 Handset:**
 # 1 3 0
- 2 :** Select a base unit number. → **[OK]**
 - This number is used by the handset as a reference only.
- 3 Base unit:**
Press and hold  for about 5 seconds.
 - If all registered handsets start ringing, press  again to stop, then repeat this step.
- 4 Handset:**
[OK] → Wait until "Base PIN" is displayed. → Enter the base unit PIN (default: "0000"). → **[OK]**
 - If you forget your PIN, contact an authorised service centre.

Selecting a base unit

When "Auto" is selected, the handset automatically uses any available base unit it is registered to. When a specific base unit is selected, the handset makes and receives calls using that base unit only. If the handset is out of range of that base unit, no calls can be made.





- 1  # 1 3 7**
- 2 :** Select the desired base unit number, or "Auto". → **[OK]**

Important:

- When viewing the phonebook, caller list, etc., only the entries that are stored in the base unit that the handset is currently connected to are displayed.





Deregistering a handset

A handset can cancel its own registration to the base unit, or other handsets registered to the same base unit. This allows the handset to end its wireless connection with the system.

- 1  # 1 3 1**
 - All handsets registered to the base unit are displayed.
- 2 :** Select the handset you want to cancel. → **[OK]**
- 3 :** "Yes" → **[OK]** → 

Cancelling a base unit

A handset can cancel a base unit that it is registered to. This allows the base unit to end its wireless connection with the system.

- 1  # 1 3 9**
- 2 :** Select the base unit you want to cancel. → **[OK]**
- 3 :** "Yes" → **[OK]** → 

Increasing the range of the base unit



You can increase the signal range of the base unit by using a DECT repeater. Please use only the Panasonic DECT repeater noted on

page 3. Contact your Panasonic dealer for details.

Important:

- Before registering the repeater to this base unit, you must turn the repeater mode on.
- If you want to register 2 or more repeaters to the base unit, contact an authorised service centre.





Setting the repeater mode

- 1 **[] [#] [1] [3] [6]**
- 2 **[]**: Select the desired setting. → **[OK]**
→ **[]**

Registering the DECT repeater (KX-A405/KX-A406) to the base unit

Note:

- Please use a repeater that has not yet been registered to another unit. If the repeater is registered to another unit, deregister it first, referring to the Installation Guide for the DECT repeater.

- 1 **Base unit:**
Press and hold **[]** for about 5 seconds.
- 2 **DECT repeater:**
Connect the AC adaptor, then wait until the ** indicator and  indicator light green.**
- 3 **Base unit:**
To exit the registration mode, press **[]**.

Caller ID Service

Using Caller ID service

Important:

- This unit is Caller ID compatible. To use Caller ID features, you must subscribe to a Caller ID service. Contact your phone service provider for details.

Caller ID features

When an outside call is being received, the caller information is displayed.

Caller information for the last 50 callers is logged in the caller list from the most recent call to the oldest.

- If the unit cannot receive caller information, the following is displayed:
 - “Out of Area”/“Out of Area”^{*1}: The caller dials from an area which does not provide a Caller ID service.
 - “Private Caller”/“Private Caller”^{*1}: The caller requests not to send caller information.
- If the unit is connected to a PBX system, caller information may not be properly received. Contact your PBX supplier.

*1 Shown while viewing the caller list.

Missed calls

If a call is not answered, the unit treats it as a missed call and **[↔]** is displayed. This lets you know if you should view the caller list to see who called while you were away.

Even if only one missed call in the caller list is viewed (page 28), **[↔]** disappears from the display. When you receive another new call, **[↔]** is displayed again.

Note:

- Even when there are unviewed missed calls, **[↔]** disappears from the standby display if the following operation is performed by one of the registered handsets:
 - Being replaced on the base unit or charger.
 - Pressing **[📞]**.

Phonebook name display

When caller information is received and it matches a phone number stored in the phonebook, the stored name in the phonebook is displayed and logged in the caller list.

Caller list

Important:

- Make sure the unit's date and time setting is correct (page 12).

Viewing the caller list and calling back

- 1 **[↔]**
- 2 Press **[▼]** to search from the most recent call, or press **[▲]** to search from the oldest call.
- 3 To call back, press **[📞]**.
To exit, press **[📞]**.

Note:

- If **[▶]** is displayed in step 2, not all of the information is shown. To see the remaining information, press **[▶]**. To return to the previous screen, press **[◀]**.
- If the entry has already been viewed or answered, “✓” is displayed.

Editing a caller's phone number

- 1 **[↔]**
- 2 **[↕]**: Select the desired entry. → **[📞]**
- 3 **[↕]**: “Edit & Call” → **[OK]**
- 4 Edit the number.
- 5 **[📞]**

Erasing selected caller information

- 1 **[↔]**
- 2 **[↕]**: Select the desired entry.

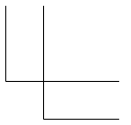
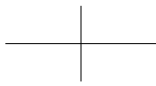
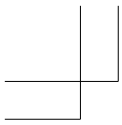

Caller ID Service

3 [X] → [↕]: “Yes” → [OK] → [📞]

Erasing all caller information

1 [→]

2 [X] → [↕]: “Yes” → [OK] → [📞]

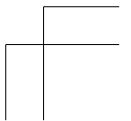
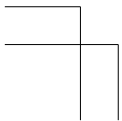
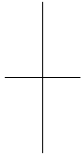



Useful Information

Voice mail service

Voice mail is an answering service that may be offered by your phone service provider. This service can also record calls when you are unavailable to answer the phone or when your line is busy. Messages are recorded on the phone company system.







When you have new messages,  is displayed on the handset if message indication service is available. Please contact your phone service provider for details of this service.

Important:

- If  still remains on the display even after you have listened to new messages, turn it off by pressing and holding  for 2 seconds.

Character entry



The dial keys are used to enter characters and numbers. Each dial key has multiple characters assigned to it. The characters that can be entered depend on the character entry mode (page 30).

- Press  or  to move the cursor left or right.
- Press dial keys to enter characters and numbers.
- Press  to erase the character or number highlighted by the cursor. Press and hold  to erase all characters or numbers.
- Press  (A→a) to switch between uppercase and lowercase.
- To enter another character located on the same dial key, press  to move the cursor to the next space, then press the appropriate dial key.
- If you do not press any dial key within 2 seconds after entering a character, the character is fixed and the cursor moves to the next space.

Character entry modes

The available character entry modes are Alphabet (ABC), Numeric (0-9), Greek (ΑΒΓ), Extended 1 (ÄÄÄ), Extended 2 (ŠŠŠ), and Cyrillic (АБВ). When in these entry modes except Numeric, you can select which character is entered by pressing a dial key repeatedly.

When the unit displays the character entry screen:

 → : Select a character entry mode. → 

Note:

-  in the following tables represents a single space.

Alphabet character table (ABC)

0	1	2	3	4	5	6	7	8	9	#
 0	& ' () * , - . / 1	A B C 2	D E F 3	G H I 4	J K L 5	M N O 6	P Q R S 7	T U V 8	W X Y Z 9	#
		a b c 2	d e f 3	g h i 4	j k l 5	m n o 6	p q r s 7	t u v 8	w x y z 9	

Useful Information

Numeric entry table (0-9)

0	1	2	3	4	5	6	7	8	9	#
0	1	2	3	4	5	6	7	8	9	#

Greek character table (ΑΒΓ)

0	1	2	3	4	5	6	7	8	9	#
~ 0	& ' () *, - . / 1	Α Β Γ 2	Δ Ε Ζ 3	Η Θ Ι 4	Κ Λ Μ 5	Ν Ξ Ο 6	Π Ρ Σ 7	Τ Υ Φ 8	Χ Ψ Ω 9	#

Extended 1 character table (ΑĂÄ)

0	1	2	3	4	5	6	7	8	9	#
~ 0	& ' () *, - . / 1	Α Ă Ä Ă Ä Ä Ă Æ Β Ç Ç 2	Δ Ę Ę É Ę Ę Ë Ę 3 4	Ĝ Ğ Ğ Ğ Ĭ Ĭ Ĭ Ĭ 4	Ĵ Ķ Ľ 5	Μ Ν Ń Ō Ō Ō Ŏ Ŏ Ŏ ø 6	Π Ϻ ϻ 7	Τ Ů ů Ú Ů ů Ū Ū 8	Ŵ Ŷ ŷ Ÿ ŷ Ζ 9	#
		a à á â ä ä ă æ b ç ç 2	d ě è é ě ě ë Ğ 3 4	g ğ ğ ĭ ĭ ĭ 4	j k l ĺ 5	m n ñ o ò ó ö ô ö ø 6	p q r s ς β 7	t u ů ú Ů ů ū Ū 8	w Ŵ x Ŷ ŷ Ζ 9	

- The following are used for both uppercase and lowercase: ø Ŵ Ŷ ŷ

Extended 2 character table (ŚŠŠ)

0	1	2	3	4	5	6	7	8	9	#
~ 0	& ' () *, - . / 1	Α Ă Ä Ă Β Ć Ć Ć 2	Δ Ę Ę É Ę Ę Ë Ę 3 4	Ĝ Ğ Ğ Ğ Ĭ Ĭ Ĭ Ĭ 4	Ĵ Ķ Ľ Ĺ Ĺ Ĺ 5	Μ Ν Ń Ō Ō Ō Ŏ Ŏ Ŏ ø 6	Π Ϻ ϻ 7	Τ Ů ů Ú Ů ů Ū Ū 8	Ŵ Ŷ ŷ Ÿ ŷ Ζ 9	#
		a á ä Ă b c Ć Ć 2	d ě è é ě ě ë Ğ 3 4	g ğ ğ ĭ ĭ ĭ 4	j k l ĺ Ĺ Ĺ 5	m n ñ o ó ö ô ö ø 6	p q r Ŗ ř s Ś Š 7	t Ů ů ú Ů ů ū Ū 8	w Ŵ x Ŷ ŷ Ζ 9	

- The following are used for both uppercase and lowercase:

Ă Ć Ć Ę Ĺ Ĺ Ĺ Ń Ś Ś Ů ů Ŷ ŷ Ζ Ζ

Useful Information

Cyrillic character table (АБВ)

0	1	2	3	4	5	6	7	8	9	#
Г	& ' ()	А Б В	Д Е Ж	И Й К	М Н О	Р С Т	Ф Х Ц	Ш Щ	Ъ Э Ю	#
Г	* , - .	Г	З	Л	П	У	Ч	Ъ Ы	Я	
Ў	/ 1	2	3	4	5	6	7	8	9	

Error messages

Display message	Cause/solution
Base no power or No link. Reconnect AC adaptor.	<ul style="list-style-type: none">● Confirm the base unit's AC adaptor is connected to the unit and the power outlet correctly.● The handset has lost communication with the base unit. Move closer to the base unit and try again.● Unplug the base unit's AC adaptor to reset the unit. Reconnect the adaptor and try again.● The handset's registration may have been cancelled. Re-register the handset (page 26).
Check Phone Line	<ul style="list-style-type: none">● The supplied telephone line cord has not been connected yet or not connected properly. Check the connections (page 8).
Memory Full	<ul style="list-style-type: none">● The phonebook memory is full. Erase unwanted entries (page 17).● The call block list memory is full. Erase unwanted entries (page 24).● The maximum number of base units (4) is already registered to the handset. Cancel unused base unit registrations from the handset (page 26).
Use rechargeable battery.	<ul style="list-style-type: none">● A wrong type of battery such as alkaline or manganese was inserted. Use only the rechargeable Ni-MH batteries noted on page 3, 6.
You must first subscribe to Caller ID.	<ul style="list-style-type: none">● You must subscribe to a Caller ID service. Once you receive caller information after subscribing to a Caller ID service, this message will not be displayed.

Troubleshooting

If you still have difficulties after following the instructions in this section, disconnect the base unit's AC adaptor and turn off the handset, then reconnect the base unit's AC adaptor and turn on the handset.

Useful Information

General use



Problem	Cause/solution
The handset does not turn on even after installing charged batteries.	<ul style="list-style-type: none">Place the handset on the base unit or charger to turn on the handset.
The unit does not work.	<ul style="list-style-type: none">Make sure the batteries are installed correctly (page 8).Fully charge the batteries (page 9).Check the connections (page 8).Unplug the base unit's AC adaptor to reset the unit and turn off the handset. Reconnect the adaptor, turn on the handset and try again.The handset has not been registered to the base unit. Register the handset (page 26).
The handset display is blank.	<ul style="list-style-type: none">The handset is not turned on. Turn the power on (page 12).
I cannot hear a dial tone.	<ul style="list-style-type: none">Make sure that you are using the supplied telephone line cord. Your old telephone line cord may have a different wiring configuration.The base unit's AC adaptor or telephone line cord is not connected. Check the connections.Disconnect the base unit from the telephone line and connect the line to a known working telephone. If the working telephone operates properly, contact our service personnel to have the unit repaired. If the working telephone does not operate properly, contact your phone service provider.
The message indicator is flashing slowly and the handset display "Demo Mode".	<ul style="list-style-type: none">Demonstration mode is activated. To turn off demonstration mode: 【🔌】 → 【📠】#899

Menu list

Problem	Cause/solution
The display is in a language I cannot read.	<ul style="list-style-type: none">Change the display language (page 12).
I cannot activate the eco mode.	<ul style="list-style-type: none">You cannot set eco mode when you set the repeater mode "On". If required, set the repeater mode to "Off" (page 27).
I cannot register a handset to a base unit.	<ul style="list-style-type: none">The maximum number of base units (4) is already registered to the handset. Cancel unused base unit registrations from the handset (page 26).The maximum number of handsets (6) is already registered to the base unit. Cancel unused handset registrations from the base unit (page 26).You entered the wrong PIN. If you forget your PIN, contact an authorised service centre.

Useful Information

Battery recharge

Problem	Cause/solution
The handset beeps and/or  flashes.	<ul style="list-style-type: none">● Battery charge is low. Fully charge the batteries (page 9).
I fully charged the batteries, but <ul style="list-style-type: none">–  still flashes or– the operating time seems to be shorter.	<ul style="list-style-type: none">● Clean the battery ends (\oplus, \ominus) and the charge contacts with a dry cloth and charge again.● It is time to replace the batteries (page 8).

Making/answering calls, intercom

Problem	Cause/solution
 is displayed.	<ul style="list-style-type: none">● The handset is too far from the base unit. Move closer.● The base unit's AC adaptor is not properly connected. Reconnect AC adaptor to the base unit.● The handset is not registered to the base unit. Register it (page 26).● Activating eco mode reduces the range of the base unit in standby mode. If required, turn eco mode off (page 13).
Noise is heard, sound cuts in and out.	<ul style="list-style-type: none">● You are using the handset or base unit in an area with high electrical interference. Re-position the base unit and use the handset away from sources of interference.● Move closer to the base unit.● If you use a DSL/ADSL service, we recommend connecting a DSL/ADSL filter between the base unit and the telephone line jack. Contact your DSL/ADSL provider for details.
Sound quality seems to be getting worse.	<ul style="list-style-type: none">● You have registered a handset that is not recommended (page 3). The clearest sound quality is only possible by registering the recommended handset.
The handset does not ring.	<ul style="list-style-type: none">● The ringer volume is turned off. Adjust ringer volume (page 14, 20).● Do not disturb mode is turned on. Turn it off (page 23).● If the handset is registered to multiple base units, the handset may not be able to make or receive calls or communicate with the base unit when the following conditions are met.<ul style="list-style-type: none">– Base unit selection is set to "Auto" (page 21).In this case, place the handset near the base unit, then press [R/ECO] and select "Eco" or "Eco OFF". Repeat for each base unit.
I cannot make a call.	<ul style="list-style-type: none">● The dialling mode may be set incorrectly. Change the setting (page 13).● You dialled a call restricted number (page 25).● The key lock feature is turned on. Turn it off (page 16).

Useful Information

Caller ID

Problem	Cause/solution
Caller information is not displayed.	<ul style="list-style-type: none">• You must subscribe to a Caller ID service. Contact your phone service provider for details.• If your unit is connected to any additional telephone equipment, remove and plug the unit directly into the wall jack.• If you use a DSL/ADSL service, we recommend connecting a DSL/ADSL filter between the base unit and the telephone line jack. Contact your DSL/ADSL provider for details.• Other telephone equipment may be interfering with this unit. Disconnect the other equipment and try again.
Caller information is slow to display.	<ul style="list-style-type: none">• Depending on your phone service provider, the unit may display the caller's information at the 2nd ring or later. Set the first ring to "OFF" (page 20).• Move closer to the base unit.
Time on the unit has shifted.	<ul style="list-style-type: none">• Incorrect time information from incoming Caller ID changes the time. Set the time adjustment to "Manual" (off) (page 20).
The name stored in the phonebook is not fully displayed while an outside call is being received.	<ul style="list-style-type: none">• Edit the phonebook entry name to fit in 1 line of text (page 17).

Liquid damage

Problem	Cause/solution
Liquid or other form of moisture has entered the handset/base unit.	<ul style="list-style-type: none">• Disconnect the AC adaptor and telephone line cord from the base unit. Remove the batteries from the handset and leave to dry for at least 3 days. After the handset/base unit are completely dry, reconnect the AC adaptor and telephone line cord. Insert the batteries and charge fully before use. If the unit does not work properly, contact an authorised service centre.

Caution:

- To avoid permanent damage, do not use a microwave oven to speed up the drying process.

Index

Index

- A** Additional base units: 26
Additional handsets: 25
Alarm: 23
Answering calls: 14
Auto talk: 14, 21
- B** Base unit
 - Cancelling: 26
 - Selecting: 26Battery: 8, 9
- C** Call restriction: 25
Call share: 15
Call waiting: 15
Call Waiting Caller ID: 15
Caller ID service: 28
Caller list: 28
Caller list edit: 28
Chain dial: 17
Character entry: 30
Conference calls: 15
Control type: 11
- D** Date and time: 12
Dialling mode: 13
Direct command code: 19
Display
 - Contrast: 21
 - Language: 12Do not disturb mode: 23
- E** Eco mode: 13
Equalizer: 15
Error messages: 32
- F** First ring: 20
- H** Handset
 - Deregistration: 26
 - Locator: 10
 - Name: 25
 - Registration: 26Hold: 14
- I** Intercom: 16
- K** Key lock: 16
Keytones: 21
- M** Making calls: 14
Message indicator: 13
Missed calls: 28
Mute: 14
- N** Nuisance call block: 24
- P** Pause: 14
Phonebook: 17
PIN: 25
Power failure: 9
Power on/off: 12
Privacy mode: 21
- R** Recall/flash: 15
Redialling: 14
Repeater: 26
Ringer tone: 20
- S** Speakerphone: 14
Speed dial: 18
- T** Temporary tone dialling: 15
Time adjustment: 20
Transferring calls: 15
Troubleshooting: 32
- V** Voicemail: 30
Volume
 - Receiver: 14
 - Ringer (Handset): 14, 20
 - Speaker: 14

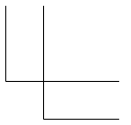
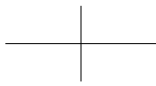
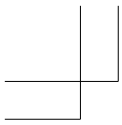

Notes

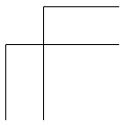
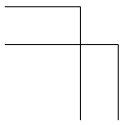
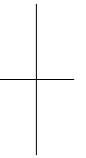
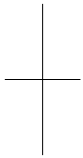

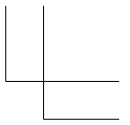
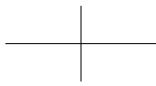
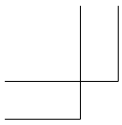

Notes

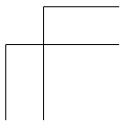
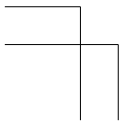
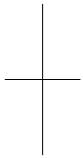

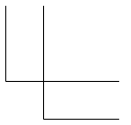
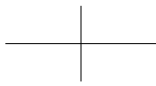
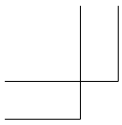

Notes

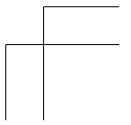
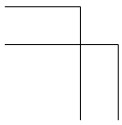
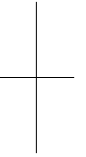
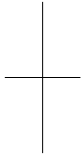

For your future reference

We recommend keeping your warranty card and a record of the following information to assist with any repair under warranty.

Serial No.	Date of purchase
(found on the bottom of the base unit)	
Name and address of dealer	

Hotline Tel. No.: 2313 0666

Sole Agent for Hong Kong & Macau:

Shun Hing Technology Co., Ltd.

Block B, 9/F., Peninsula Centre 67 Mody Road Tsimshatsui East Kowloon,
Hong Kong

Tel: 2313 0888

Hotline: 2313 0666

Fax: 2368 8068

Email address: shtec@panasonic.oa.hk

Panasonic Corporation

1006, Oaza Kadoma, Kadoma-shi, Osaka 571-8501, Japan
<http://www.panasonic.com>

© Panasonic Corporation 2017



PNQX8610ZA

PNQX8610ZA PP0817MU0